

Safety Precautions

WARNING!



Liquids:

- Never allow the motor unit on the knife sharpener to come into contact with water or other liquids as there is a risk of electric shock and/or damage to the unit.
- Under no circumstances should lubricants or other liquids come into contact with the sharpening wheels, with the exception of water for cleaning (see cleaning instructions).

Repair:

- Under no circumstances should this knife sharpener be modified or repaired by yourself or any other person not authorised to do so by KAI EUROPE GmbH. Failure to observe this may result in injury and loss of any warranty claims.

Adherence to the instructions:

- Strict adherence to the instructions given in this operating manual is essential for the safe operation of the unit and for the maintenance of any warranty claims.

Power supply:

- This knife sharpener should only be operated using a 220-240V, 50Hz, 60W power supply.

Exposure to sunlight/heat sources:

- Never operate the sharpener in direct sunlight or near an open fire.

Duration of use:

- Never operate the knife sharpener for more than 2 minutes without interruption, otherwise there is a risk of overheating and damage to the motor.

Surface:

- Always operate the sharpener on a flat and solid surface.
- This knife sharpener should not be used outdoors.

Pressure:

- Never apply "undue" pressure when sharpening a knife.

Work safety:

- Make sure that no hair, clothing or jewellery can get into the knife sharpener.

Specification Data

Operating Voltage	220-240V, 50Hz, 60W
Wattage	60 Watts
MAXIMUM Operating Time	2 Minutes
Dimensions	138 (L) x 111 (W) x 105 (H) mm
Weight	875 grammes
Exclusively Designed for use with:	Household knives with double-edged blade made of steel

Cleaning and Maintenance: Clean the sharpener after every use; the outer surfaces with a dishcloth and mild detergent - wipe properly dry. Do not use any benzine, thinner or impregnated cleaning cloths as these are most likely to spoil the surface finish!

To clean the Grindstone Cartridge proceed as follows:

1. Push the Snap Lock tab down and pull the cartridge towards you and off.
2. Hold the cartridge with its Rising Water Inlet under a tap and rinse all grinding residue out of the housing. Make sure to thoroughly dry all internal components - if moisture is allowed to remain inside, it will cause damage.
3. Replace the cartridge.

Replacement sharpening units are available from your dealer.

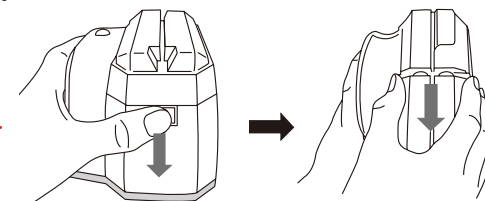

Warranty

This warranty is valid for 24 months from the date of purchase regardless of any warranty claims.

(Please complete this Warranty Certificate and file it with your documents to have it ready for submission if and when necessary)

Name: _____

Street: _____

Zip Code and Town: _____

Country: _____

Place and Date of Purchase: _____

Dealer Stamp:

KAI EUROPE GmbH will repair this appliance free of charge or replace it with an equivalent item if and when KAI EUROPE GmbH is satisfied that the claim is duly substantiated by the fact that the claimed defect is based on the original material, construction or workmanship.

For this warranty to remain valid, it is essential that the safety precautions are followed. Failure to do so will invalidate the warranty.

- The unit must be used correctly and in accordance with the instructions given in this operating manual.
- The unit must be operated in accordance with its specifications and intended use only.
- No modifications and/or repairs may be carried out by you or any other person who has not been authorised to do so by KAI EUROPE GmbH.
- If the supply cord is damaged it must be replaced by the manufacturer, its service agent or similiary qualified person in order to avoid Hazard.

Any claim under this Warranty will only be accepted if and when accompanied by the duly completed warranty certificate and proof of purchase from your dealer or KAI EUROPE GmbH.

KAI EUROPE GmbH

Kottendorfer Str. 5, 42697 Solingen, Germany
Phone: +49 (0) 212 23 23 80
Fax: +49 (0) 212 23 23 899
E-Mail: info@kai-europe.com
www.kai-europe.com

KAI FRANCE SARL

62, Boulevard Garibaldi, Paris 75015, Paris, France
Phone: +33 (0) 9 73 87 36 80
Fax: +33 (0) 1 42 72 80 41
www.kai-europe.com



Electric Knife Sharpener

Operating Instructions and Warranty

Thank you for choosing this KAI Electric Knife Sharpener.
Please read these Operating Instructions carefully to familiarize yourself with the details of this sharpener so as to obtain the desired results without running any risk whatever!

Safety Precautions



CAUTION!

Damaged plug/power cable:

- Under no circumstances should the knife sharpener be used with a damaged plug and/or power cable.
- In order to avoid hazards, a damaged power cable and/or plug should only be replaced by the manufacturer, a customer service centre or a similarly qualified technician.

Separation from the mains:

- Always switch off and unplug the unit immediately after use, when leaving it unattended, before assembly, dismantling, cleaning, replacing accessories or before approaching moving parts during operation.
- Never use the power cord to pull the plug out of the power outlet.

Children:

- This unit is not allowed to be used by children. Keep the unit and its cable out of the reach of children.

Disabled persons:

- The unit is safe for use by persons with reduced physical, sensory or mental capabilities, or who lack experience and/or knowledge, if they have been given supervision or instruction concerning its safe use and understand the risks involved.

The components of this knife sharpener

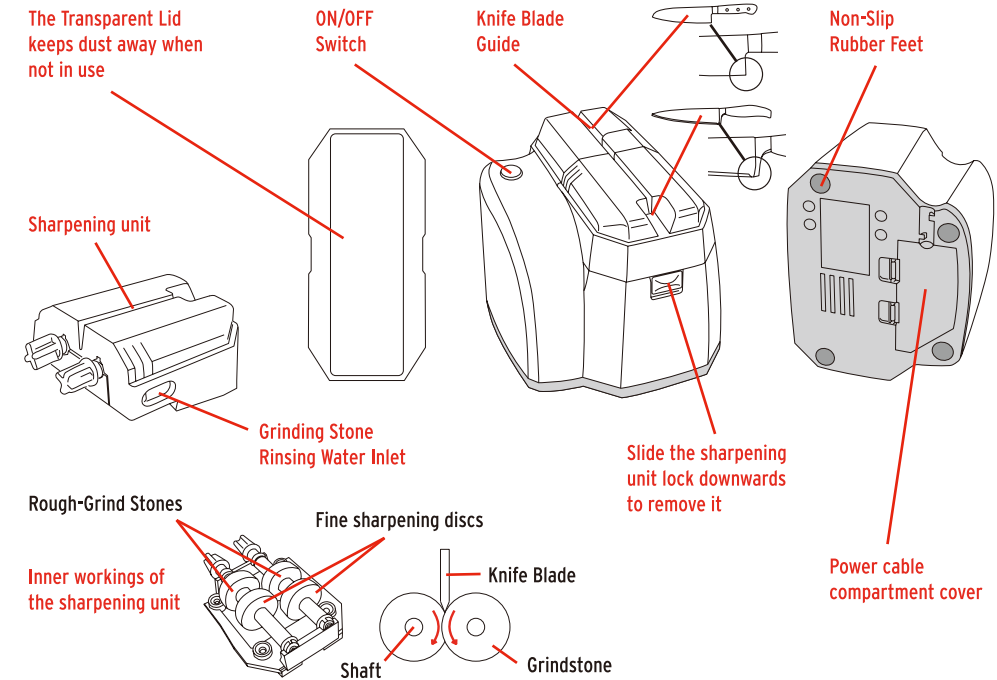

Working with the KAI Knife Sharpener

1. Removing the power cable:

Press the cover latch down with your thumbs as shown. Place the cable back in the compartment after use.

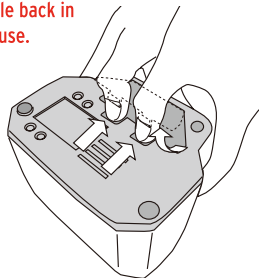

3. Place the sharpener on a flat and solid surface and connect the power cord plug to the mains.

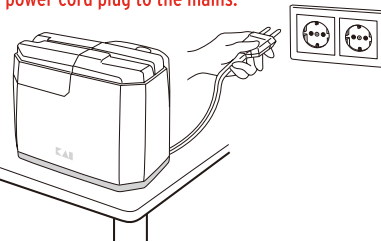

2. Pass the cable under the lugs on the cable duct and replace the cover as shown.

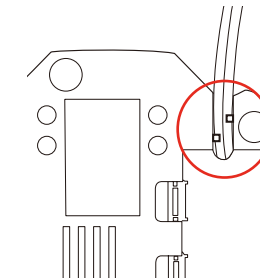

4. Remove the Transparent Lid.

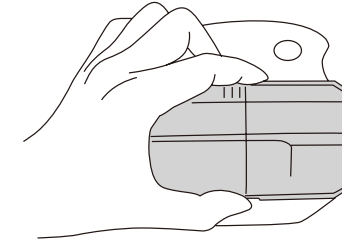

5. Clean and dry the knife to be sharpened thoroughly.

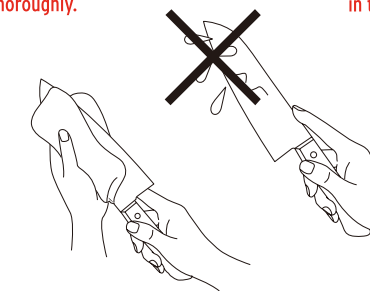

6. Set the Switch to "on" and insert the blade edge - as shown - in the Knife Blade Guide Channel.

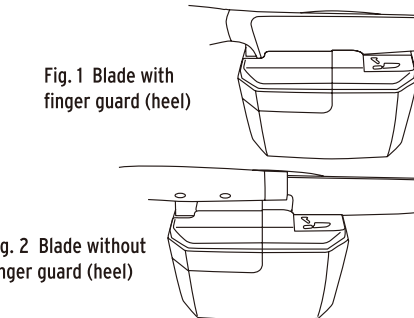

7. Run the blade straight, slowly and evenly within the Guide Channel and back as shown.

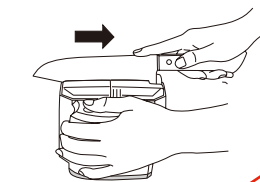

Make sure that the blade is kept upright during the process!

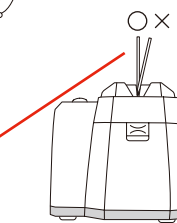

8. Once you reach the curved portion of the blade edge: Raise the handle to follow the edge contour so as to keep in contact with the grindstones!

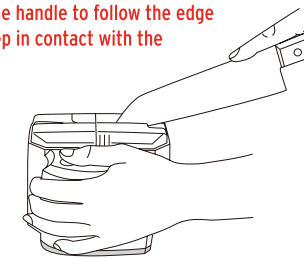

9. Clean and dry the blade thoroughly after sharpening (see step 5).

HELPFUL ADVICE to obtain a keen edge

- Hold the knife by the handle and apply light pressure with your forefinger on the knife as you pull it through the sharpener!.
- Under no circumstances should the sharpening process be interrupted. It always takes a full pass to produce a keen edge!
- Always run the blade straight, slowly and evenly within the Guide Channel and back!
- Make sure that the knife is guided under light and steady pressure through the sharpener!

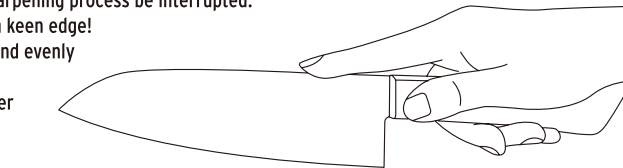

NOTE: Knives will, in the long run, leave slight scratch marks on the guide channel outlet, which affects in no way the proper function of the sharpener and does not represent reason for any Warranty claim!

IMPORTANT: This Knife Sharpener is designed for use with symmetrically ground blades made of steel.

This Sharpener is not designed for use with pocket knives, serrated edge blades, scissors, technical cutter blades, etc.

Proper sharpening routine: Run the blade straight, slowly and evenly within the Guide Channel and back as shown. Once you reach the curved portion of the blade edge: Raise the handle to follow the edge contour so as to keep in contact with the grindstones! Make sure that the blade does not cant or tip during the process!

